

1 x 8 x 16 Solid Pier

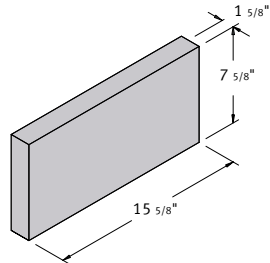

2 x 8 x 16 Solid Pier

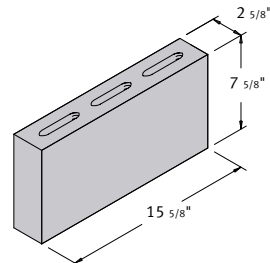

3 x 8 x 16 Hollow Pier

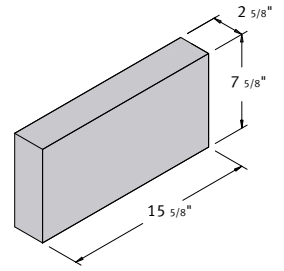

3 x 8 x 16 Solid Pier

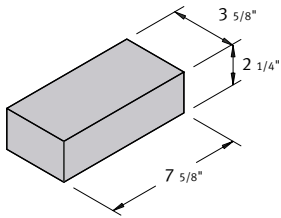

4 x 2 1/4 x 8  
Concrete Brick

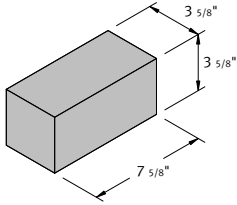

4 x 4 x 8 Solid Pier

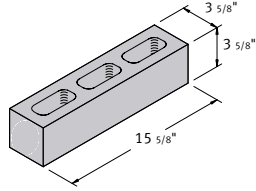

4 x 4 x 16 Hollow Pier

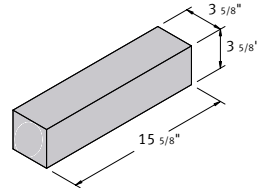

4 x 4 x 16 Solid Pier

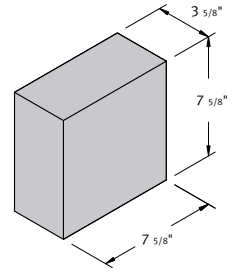

4 x 8 x 8 Solid Pier

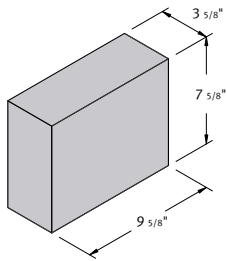

4 x 8 x 10 Solid Pier

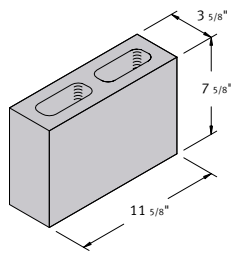

4 x 8 x 12 Hollow Pier

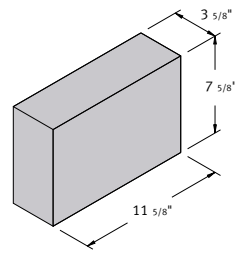

4 x 8 x 12 Solid Pier

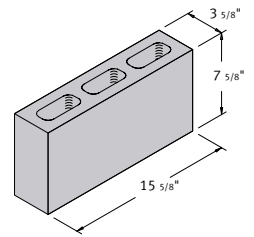

4 x 8 x 16 Hollow Pier

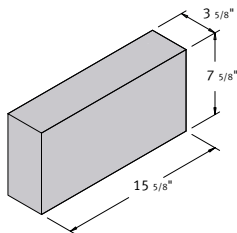

4 x 8 x 16 Solid Pier

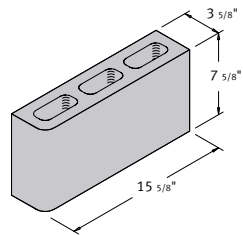

4 x 8 x 16 Hollow Single Bullnose Corner

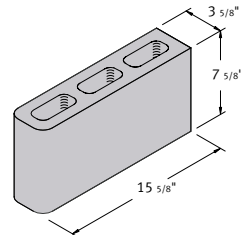

4 x 8 x 16 Hollow Double Bullnose Corner

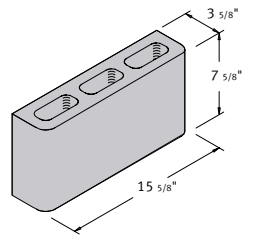

4 x 8 x 16 Hollow Single Bullnose Pier

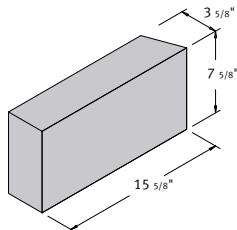

4 x 8 x 16 Solid 45 Degree

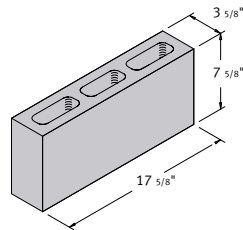

4 x 8 x 18 Hollow Pier

## 6 Inch Units

## Gray Block Products

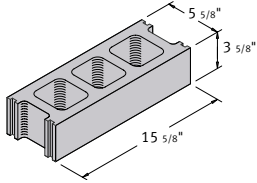

6 x 4 x 16 Hollow Stretcher

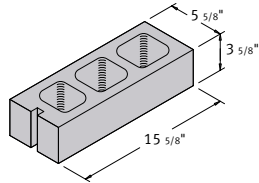

6 x 4 x 16 Hollow Corner Sash

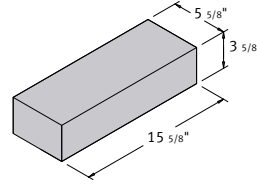

6 x 4 x 16 Solid Pier

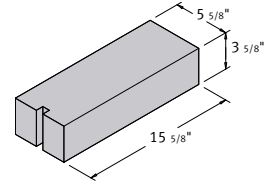

6 x 4 x 16 Solid Corner Sash

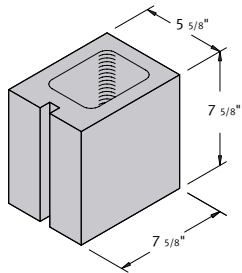

6 x 8 x 8 Hollow Corner Sash

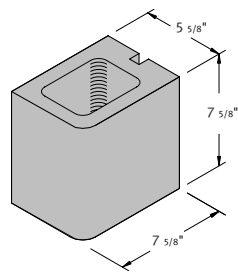

6 x 8 x 8 Hollow Single Bullnose Corner Sash

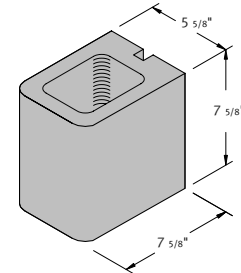

6 x 8 x 8 Hollow Double Bullnose Corner Sash

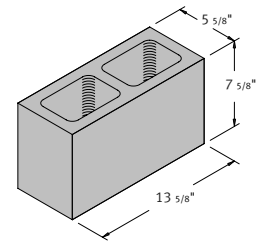

6 x 8 x 14 Hollow Pier

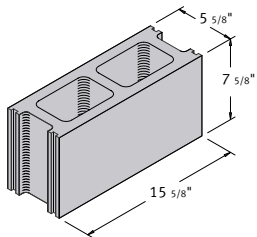

6 x 8 x 16 Hollow Stretcher

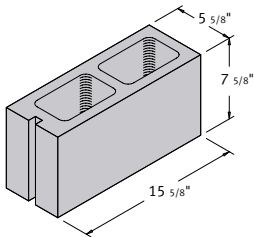

6 x 8 x 16 Hollow Corner Sash

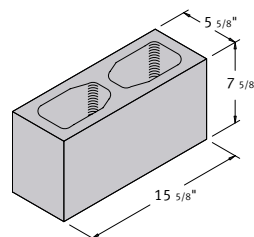

6 x 8 x 16 Hollow Pier

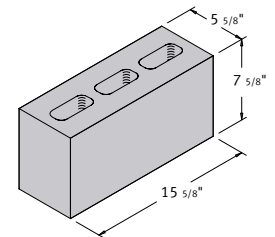

6 x 8 x 16 Semi Solid

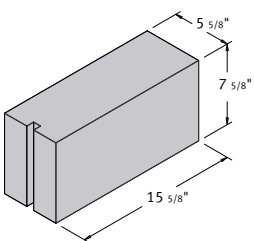

6 x 8 x 16 Solid Corner Sash

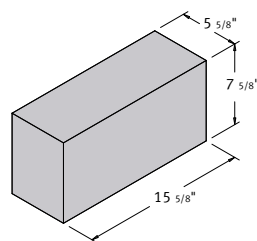

6 x 8 x 16 Solid Pier

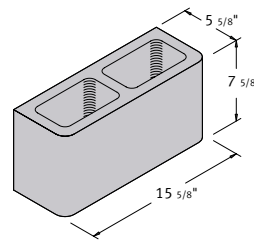

6 x 8 x 16 Hollow Single Bullnose Pier

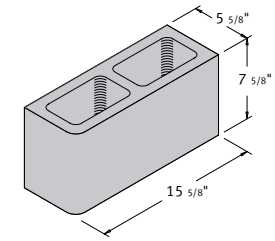

6 x 8 x 16 Hollow Single Bullnose Corner

# 6 Inch Units

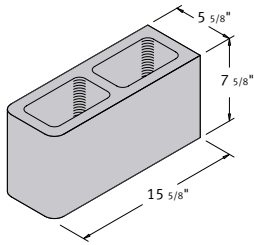

6 x 8 x 16 Hollow Double Bullnose Corner

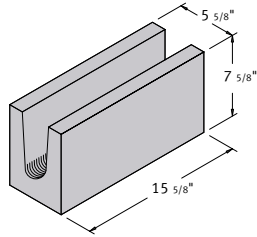

6 x 8 x 16 Solid-Bottom Bond Beam

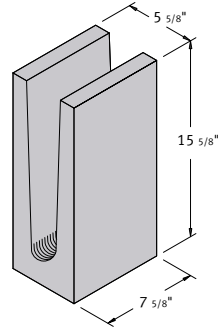

6 x 16 x 8 Bond Beam Lintel

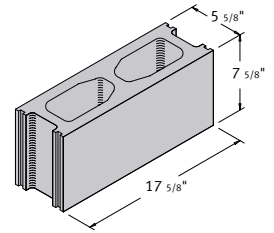

6 x 8 x 18 Hollow Stretcher

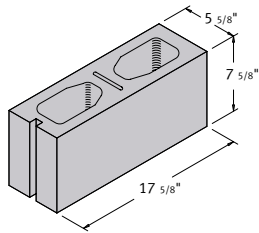

6 x 8 x 18 Hollow Corner Sash

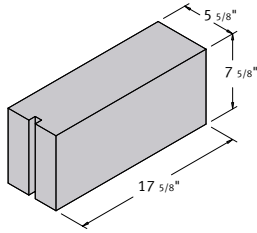

6 x 8 x 18 Solid Corner Sash

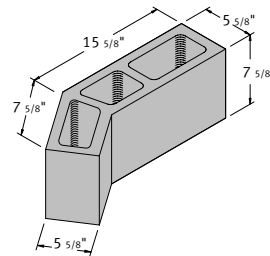

6 x 8 x 21 45 Degree Angle

# 8 Inch Units

# Gray Block Products

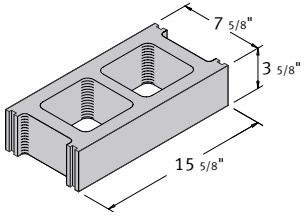

8 x 4 x 16 Hollow Stretcher

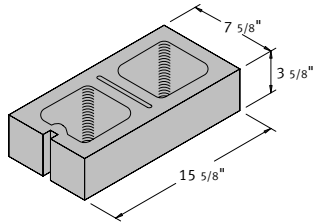

8 x 4 x 16 Hollow Corner Sash

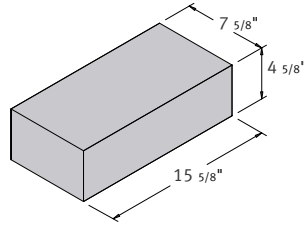

8 x 5 x 16 Solid Pier

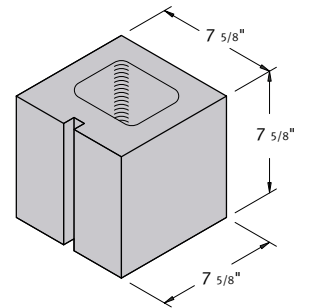

8 x 8 x 8 Hollow Corner Sash Half

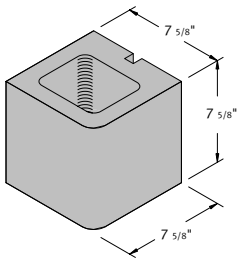

8 x 8 x 8 Hollow Single Bullnose Corner Sash

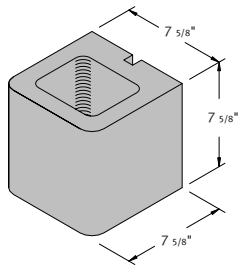

8 x 8 x 8 Hollow Double Bullnose Corner Sash

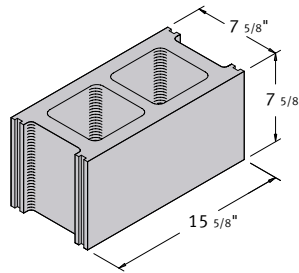

8 x 8 x 16 Hollow Stretcher

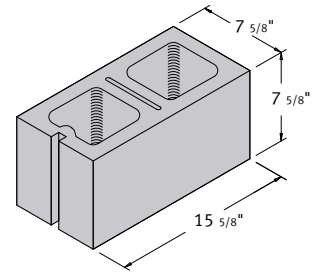

8 x 8 x 16 Hollow Corner Sash

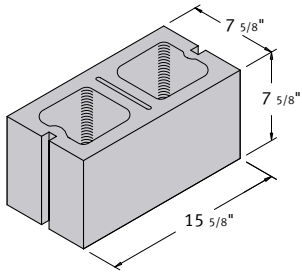

8 x 8 x 16 Hollow Double Sash

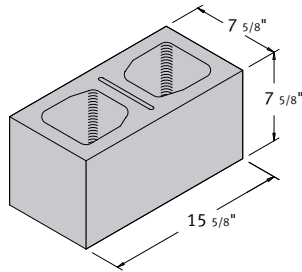

8 x 8 x 16 Hollow Pier

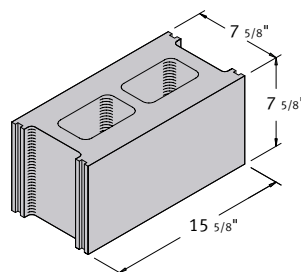

8 x 8 x 16 Hollow 3 Hour Fire Rated

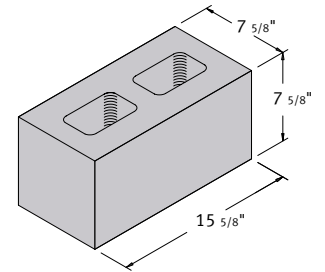

8 x 8 x 16 Semi Solid Pier

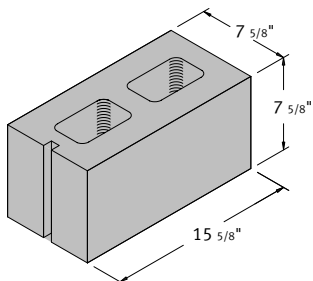

8 x 8 x 16 Semi Solid Corner Sash

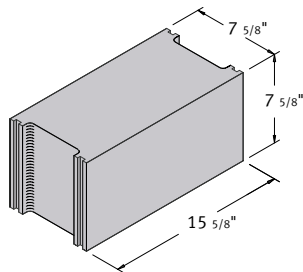

8 x 8 x 16 Solid Stretcher

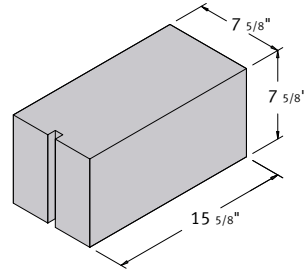

8 x 8 x 16 Solid Corner Sash

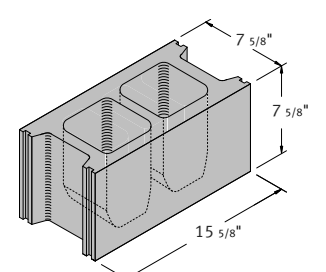

8 x 8 x 16 Hollow Cap

# 8 Inch Units

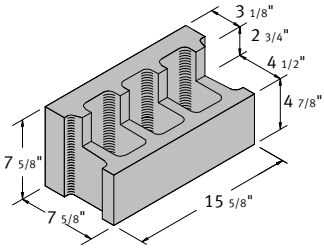

8 x 8 x 16 Hollow Header

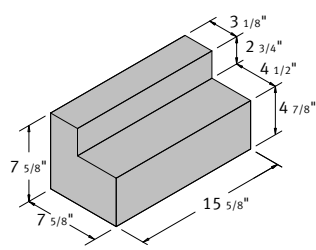

8 x 8 x 16 Solid Header Pier

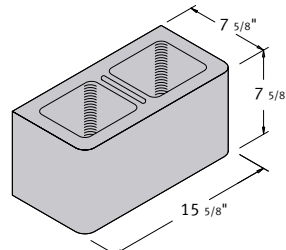

8 x 8 x 16 Hollow Single Bullnose Pier

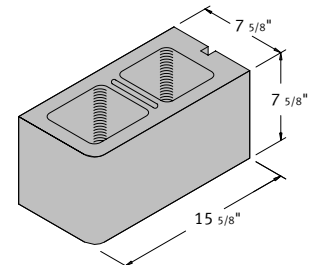

8 x 8 x 16 Hollow Single Bullnose Corner Sash

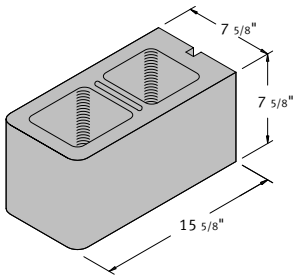

8 x 8 x 16 Hollow Double Bullnose Corner Sash

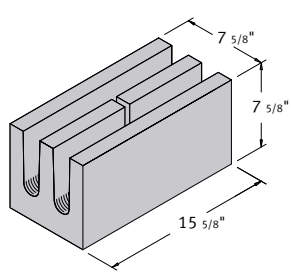

8 x 8 x 16 Solid-Bottom Bond Beam

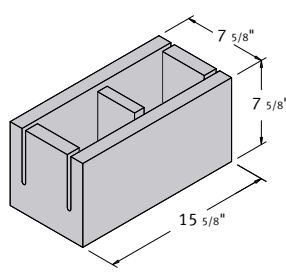

8 x 8 x 16 Knock-Out Bond Beam

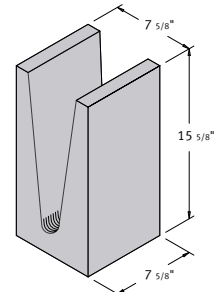

8 x 16 x 8 Bond Beam Lintel

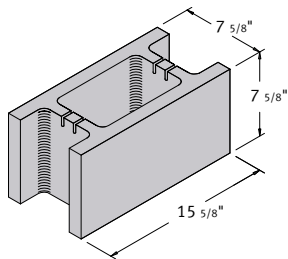

8 x 8 x 16 Open End

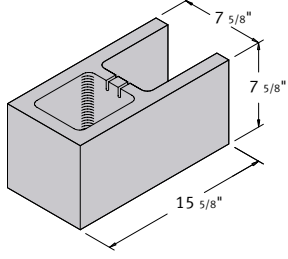

8 x 8 x 16 A Shaped Block

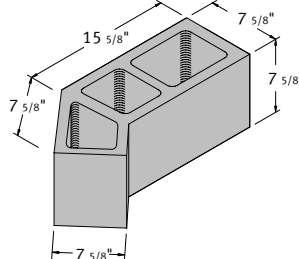

8 x 8 x 21 45 Degree Angle

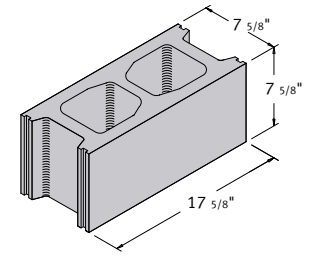

8 x 8 x 18 Hollow Stretcher

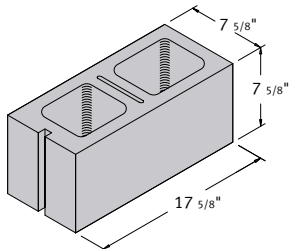

8 x 8 x 18 Hollow Corner Sash

10 Inch Units

Gray Block Products

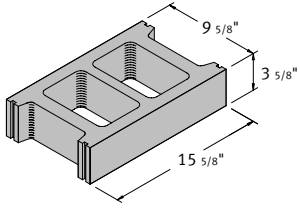

10 x 4 x 16 Hollow Stretcher

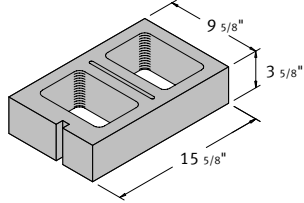

10 x 4 x 16 Hollow Corner Sash

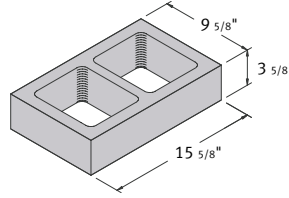

10 x 4 x 16 Hollow Pier

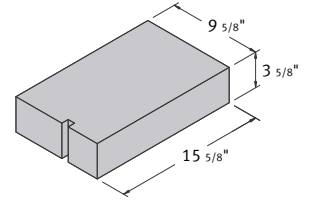

10 x 4 x 16 Solid Corner Sash

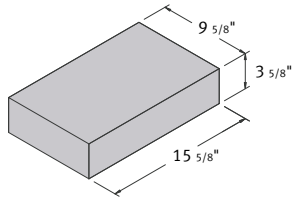

10 x 4 x 16 Solid Pier

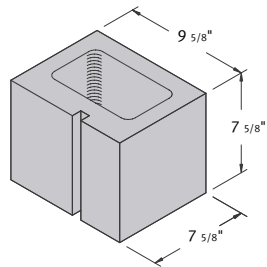

10 x 8 x 8 Hollow Corner Sash

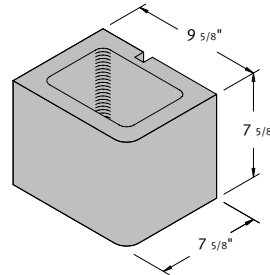

10 x 8 x 8 Hollow Single Bullnose Corner Sash

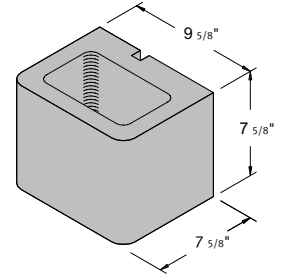

10 x 8 x 8 Hollow Double Bullnose Corner Sash

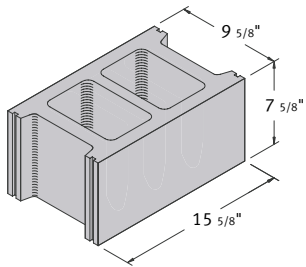

10 x 8 x 16 Hollow Stretcher

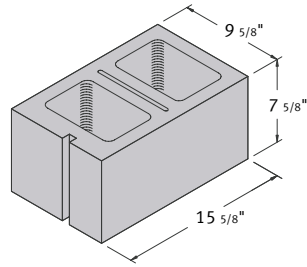

10 x 8 x 16 Hollow Corner Sash

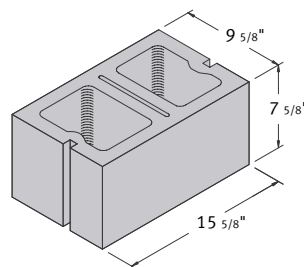

10 x 8 x 16 Hollow Double Sash

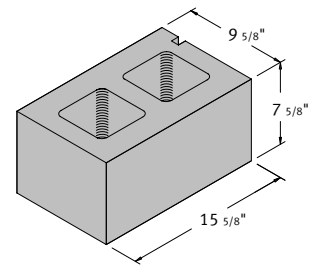

10 x 8 x 16 Semi Solid Pier

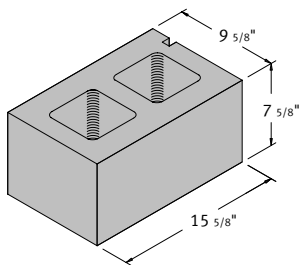

10 x 8 x 16 Semi Solid Corner Sash

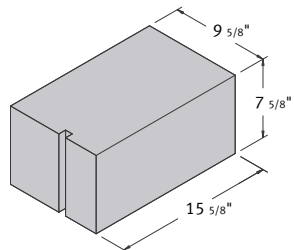

10 x 8 x 16 Solid Corner Sash

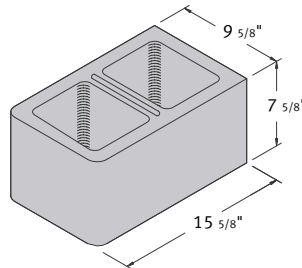

10 x 8 x 16 Hollow Double Bullnose Corner

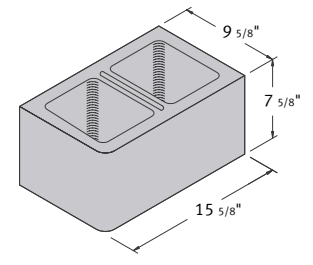

10 x 8 x 16 Hollow Single Bullnose Corner

10 Inch Units

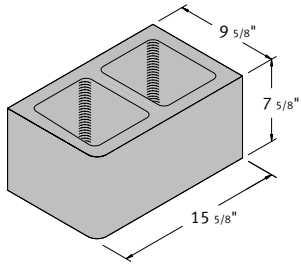

10 x 8 x 16 Hollow Single Bullnose Pier

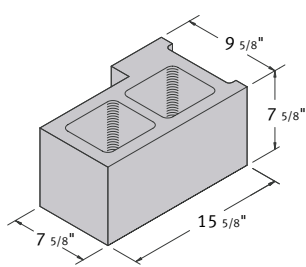

10 x 8 x 16 Hollow Return Corner

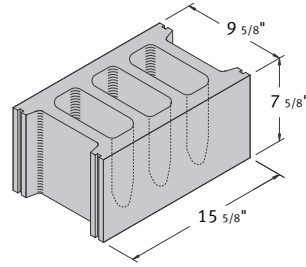

10 x 8 x 16 Hollow Cap 3 Core

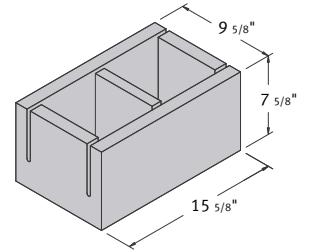

10 x 8 x 16 Knock-Out Bond Beam

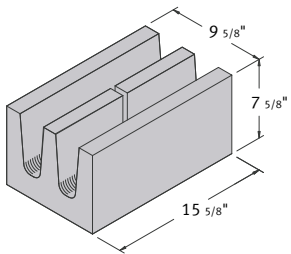

10 x 8 x 16 Solid-Bottom Bond Beam

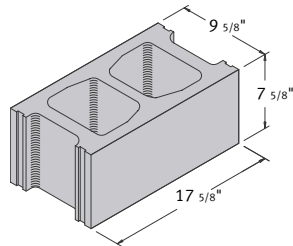

10 x 8 x 18 Hollow Stretcher

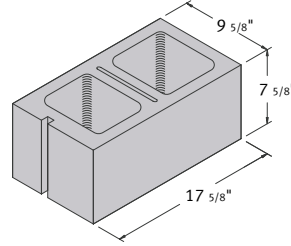

10 x 8 x 18 Hollow Corner Sash

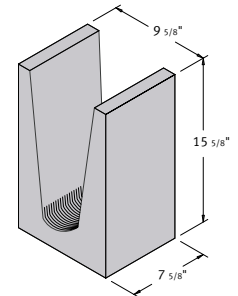

10 x 16 x 8 Bond Beam Lintel

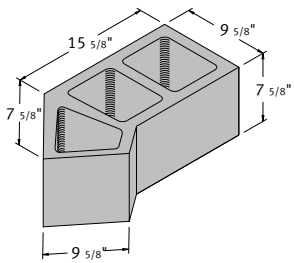

10 x 8 x 21 45 Degree Angle



12 Inch Units

Gray Block Products

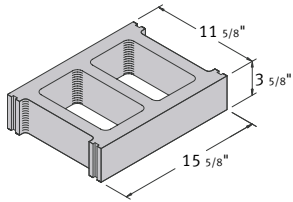

12 x 4 x 16 Hollow Stretcher

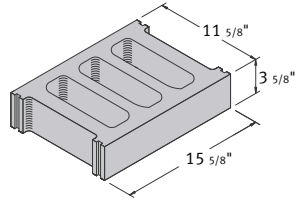

12 x 4 x 16 Hollow Stretcher

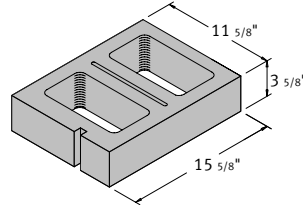

12 x 4 x 16 Hollow Corner Sash

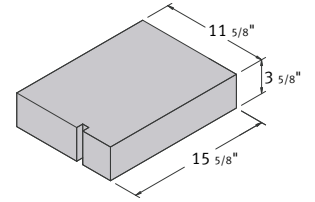

12 x 4 x 16 Solid Corner Sash

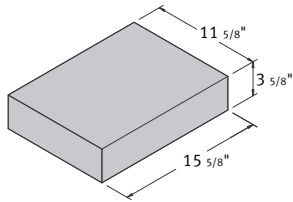

12 x 4 x 16 Solid Pier

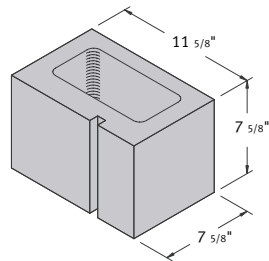

12 x 8 x 8 Hollow Corner Sash

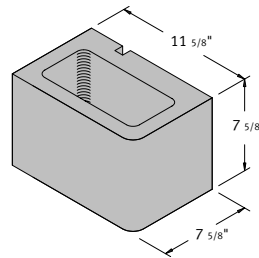

12 x 8 x 8 Hollow Single Bullnose Corner Sash

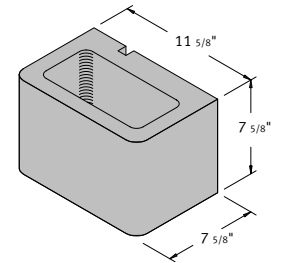

12 x 8 x 8 Hollow Double Bullnose Corner Sash

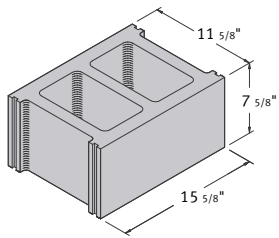

12 x 8 x 16 Hollow Stretcher

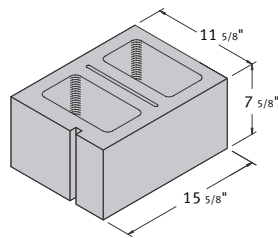

12 x 8 x 16 Hollow Corner Sash

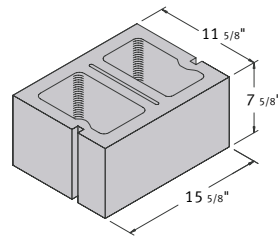

12 x 8 x 16 Hollow Double Sash

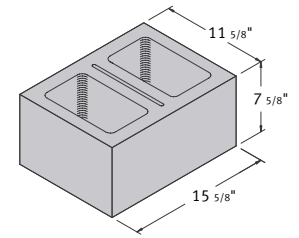

12 x 8 x 16 Hollow Pier

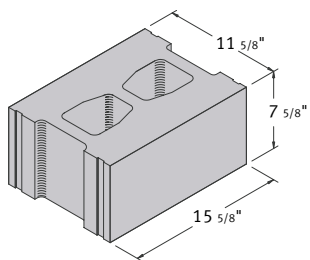

12 x 8 x 16 Semi Solid Stretcher

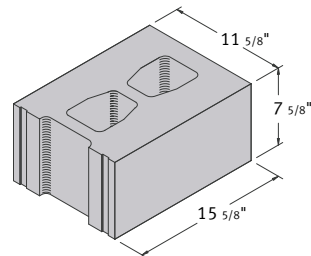

12 x 8 x 16 Semi Solid Single Corner Ear

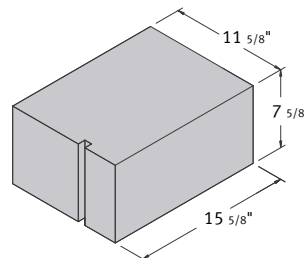

12 x 8 x 16 Solid Corner Sash

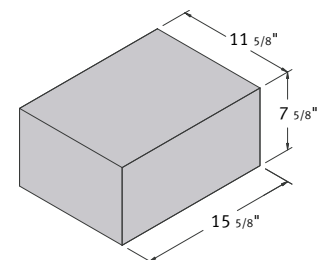

12 x 8 x 16 Solid Pier

12 Inch Units

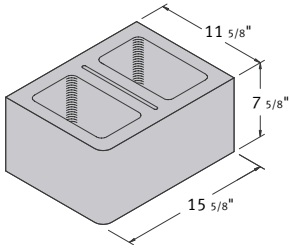

12 x 8 x 16 Hollow Single Bullnose Corner

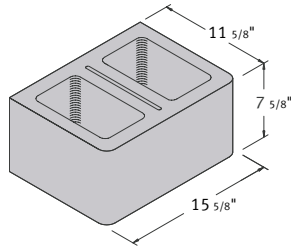

12 x 8 x 16 Hollow Single Bullnose Pier

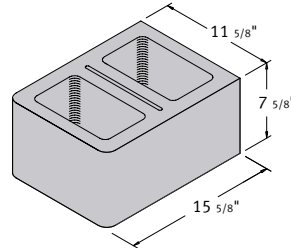

12 x 8 x 16 Hollow Double Bullnose Corner

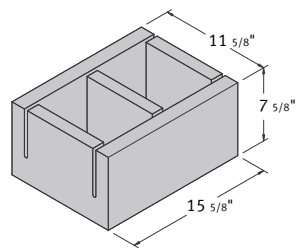

12 x 8 x 16 Knock-Out Bond Beam

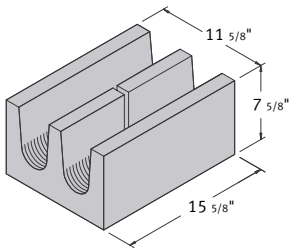

12 x 8 x 16 Solid-Bottom Bond Beam

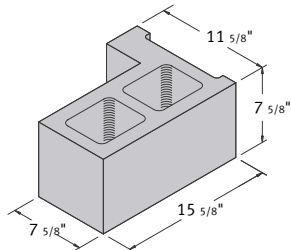

12 x 8 x 16 Hollow Return Corner

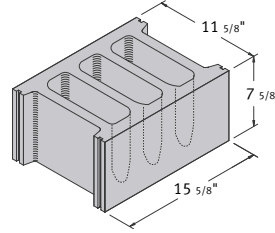

12 x 8 x 16 Hollow Cap 3 Core

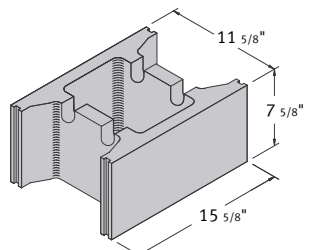

12 x 8 x 16 Open End

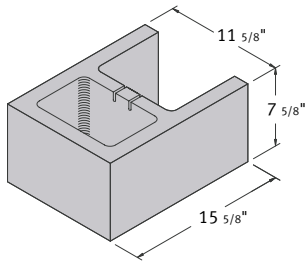

12 x 8 x 16 A Shaped Block

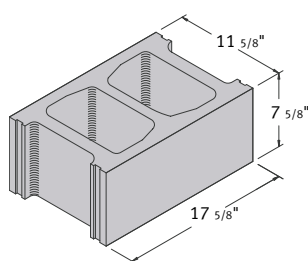

12 x 8 x 18 Hollow Stretcher

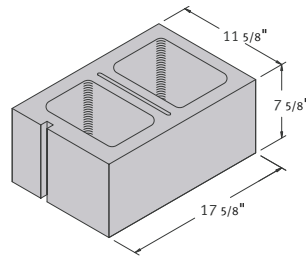

12 x 8 x 18 Hollow Corner Sash

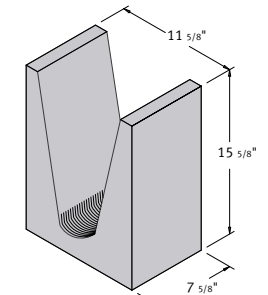

12 x 16 x 8 Bond Beam Lintel

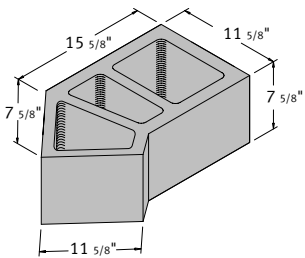

12 x 8 x 21 45 Degree Angle

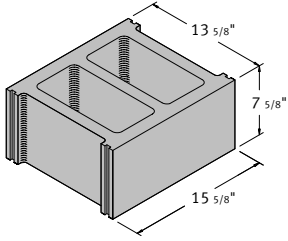

14 x 8 x 16 Hollow Stretcher

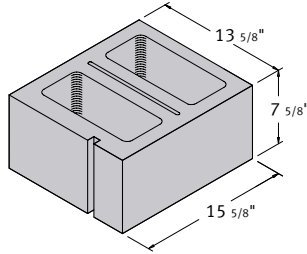

14 x 8 x 16 Hollow Corner Sash

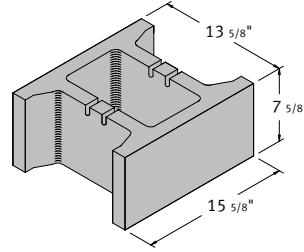

14 x 8 x 16 Open End

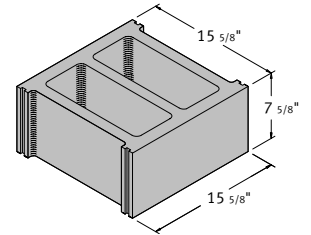

16 x 8 x 16 Hollow Stretcher

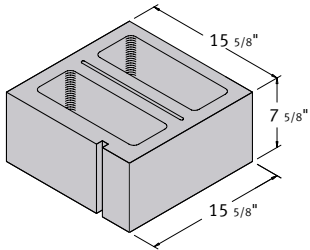

16 x 8 x 16 Hollow Corner Sash

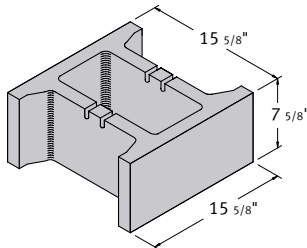

16 x 8 x 16 Open End

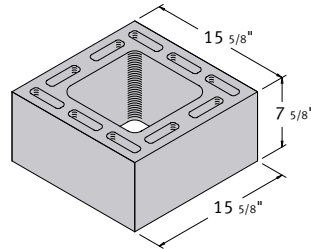

16 x 8 x 16 Chimney Block

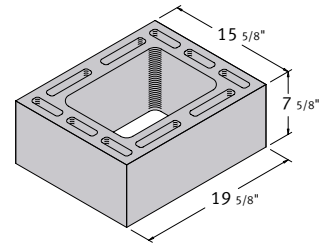

16 x 8 x 20 Chimney Block